

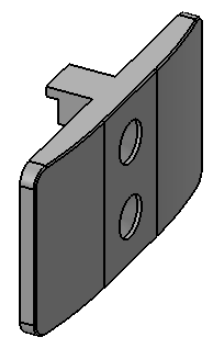

Name	Signatur	Datum	Artikelnummer	Oberfläche: Geschliffen Korn 240
Ch. Höfig	CH	31.03.2020	24-V4A-180	
Werkstoff: 1.4401/04 (X5CrNiMo17-12-2)			Hersteller	Blattformat
			 Feldmann EDELSTAHL · ALUMINIUM · SCHMIEDEEISEN	A4
Gewicht 0,484 kg		Massstab: 1:2	Version: 1	Blatt 1 von 6

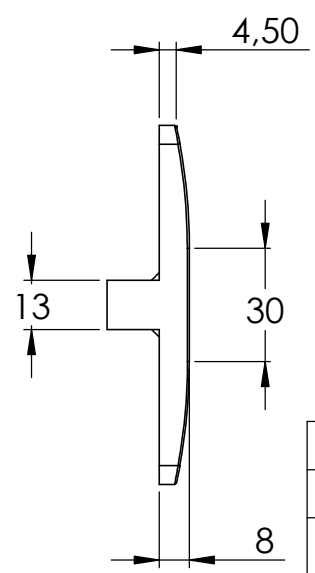

Name	Signatur	Datum	Artikelnummer	Oberfläche: Geschliffen Korn 240
Ch. Höfig	CH	31.03.2020	24-V4A-180	
Werkstoff: 1.4401/04 (X5CrNiMo17-12-2)			Hersteller	Blattformat
			 Feldmann EDELSTAHL-ALUMINIUM-SCHMIEDEISEN	A4
Gewicht 0,228 kg		Massstab: 1:2	Version: 1	Blatt 2 von 6

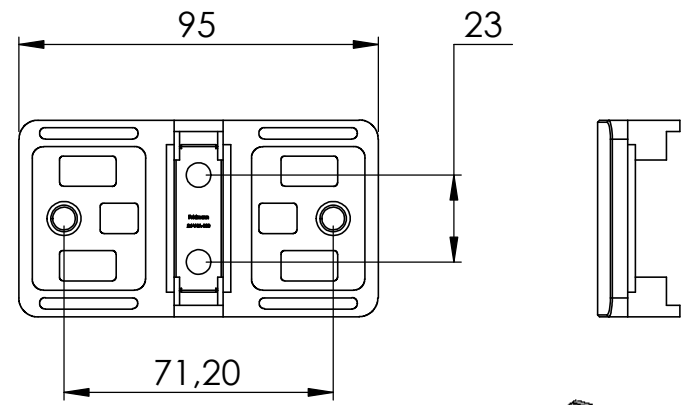
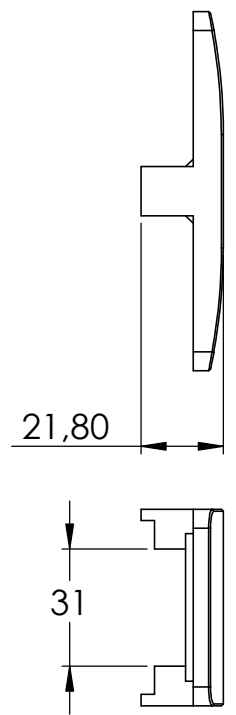
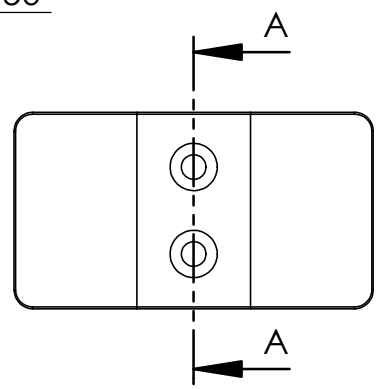
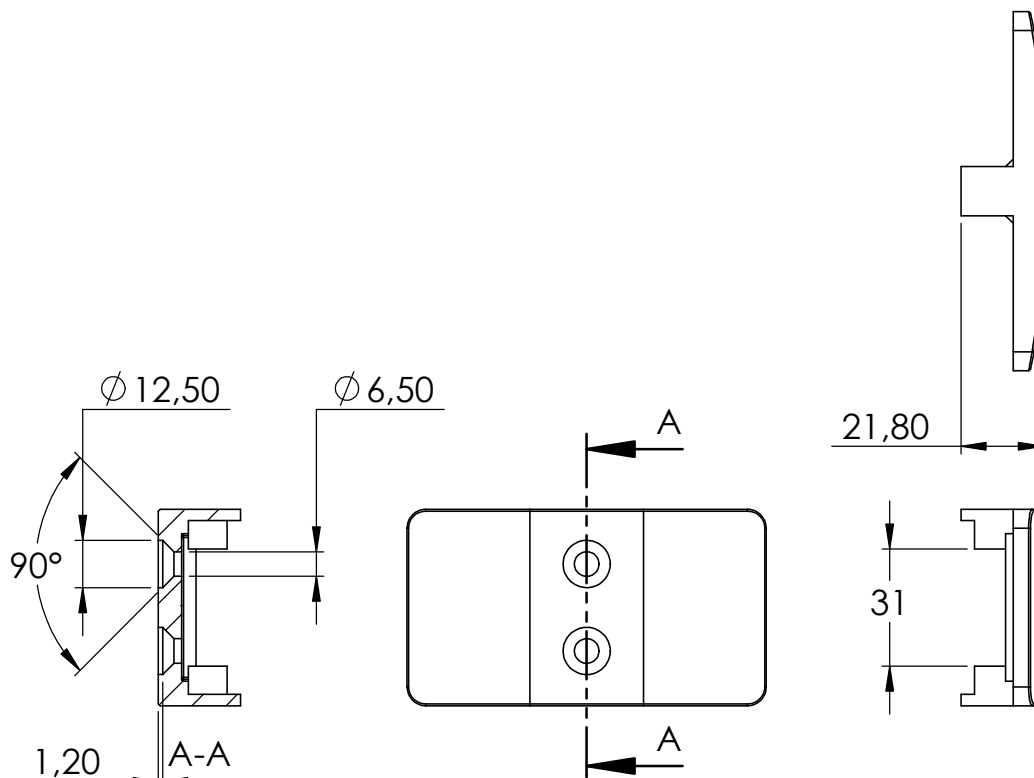

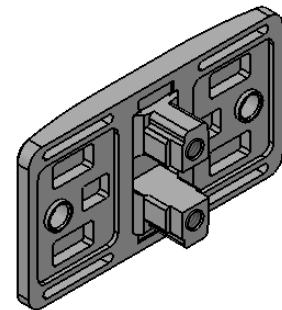
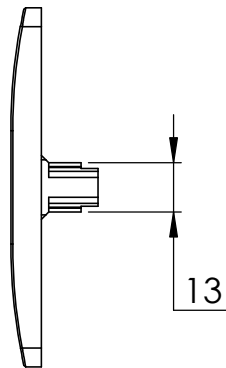
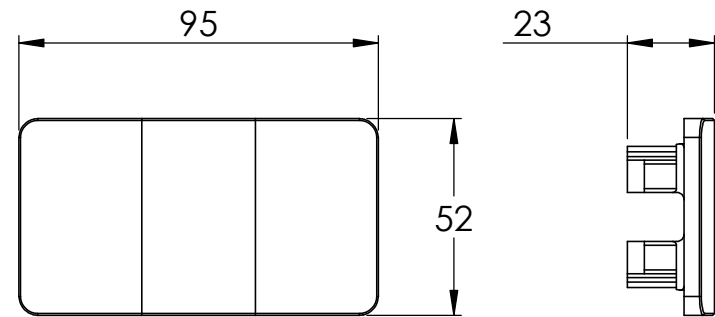
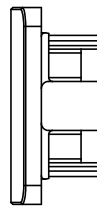
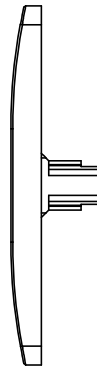
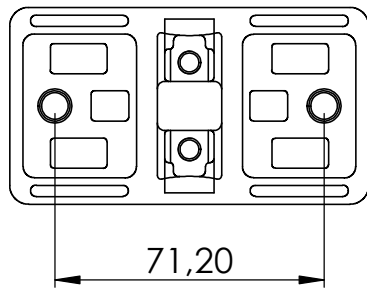
Name	Signatur	Datum	Artikelnummer	Oberfläche: Geschliffen Korn 240
Ch. Höfig	CH	31.03.2020	24-V4A-180	
Werkstoff: 1.4401/04 (X5CrNiMo17-12-2)			Hersteller	Blattformat
			 Feldmann EDELSTAHL · ALUMINIUM · SCHMIEDEEISEN	A4
Gewicht 0,246 kg		Massstab: 1:2	Version: 1	Blatt 3 von 6

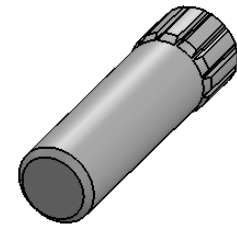
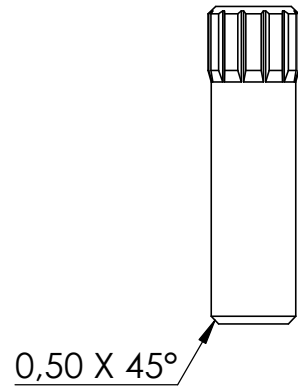
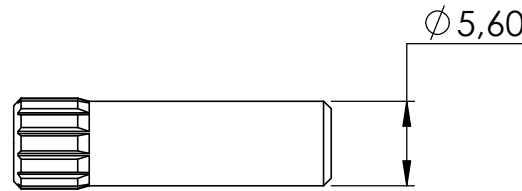
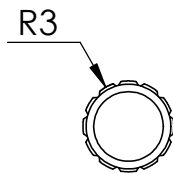
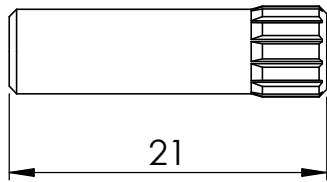
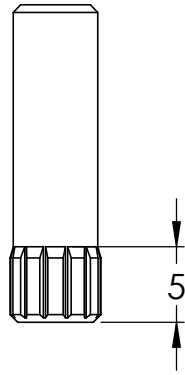

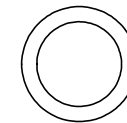
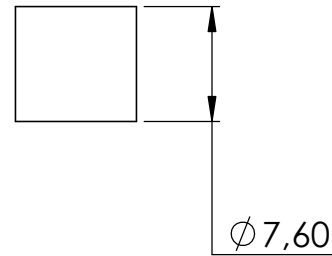
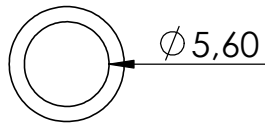
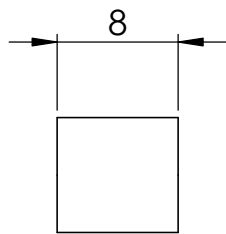

Name	Signatur	Datum	Artikelnummer	Oberfläche: Roh
Ch. Höfig	CH	31.03.2020	24-Stift	
Werkstoff: 1.4401/04 (X5CrNiMo17-12-2)			Hersteller	Blattformat
			 Feldmann EDELSTAHL · ALUMINIUM · SCHMIEDEISEN	A4
Gewicht 0,004 kg		Massstab: 2:1	Version: 1	Blatt 4 von 6

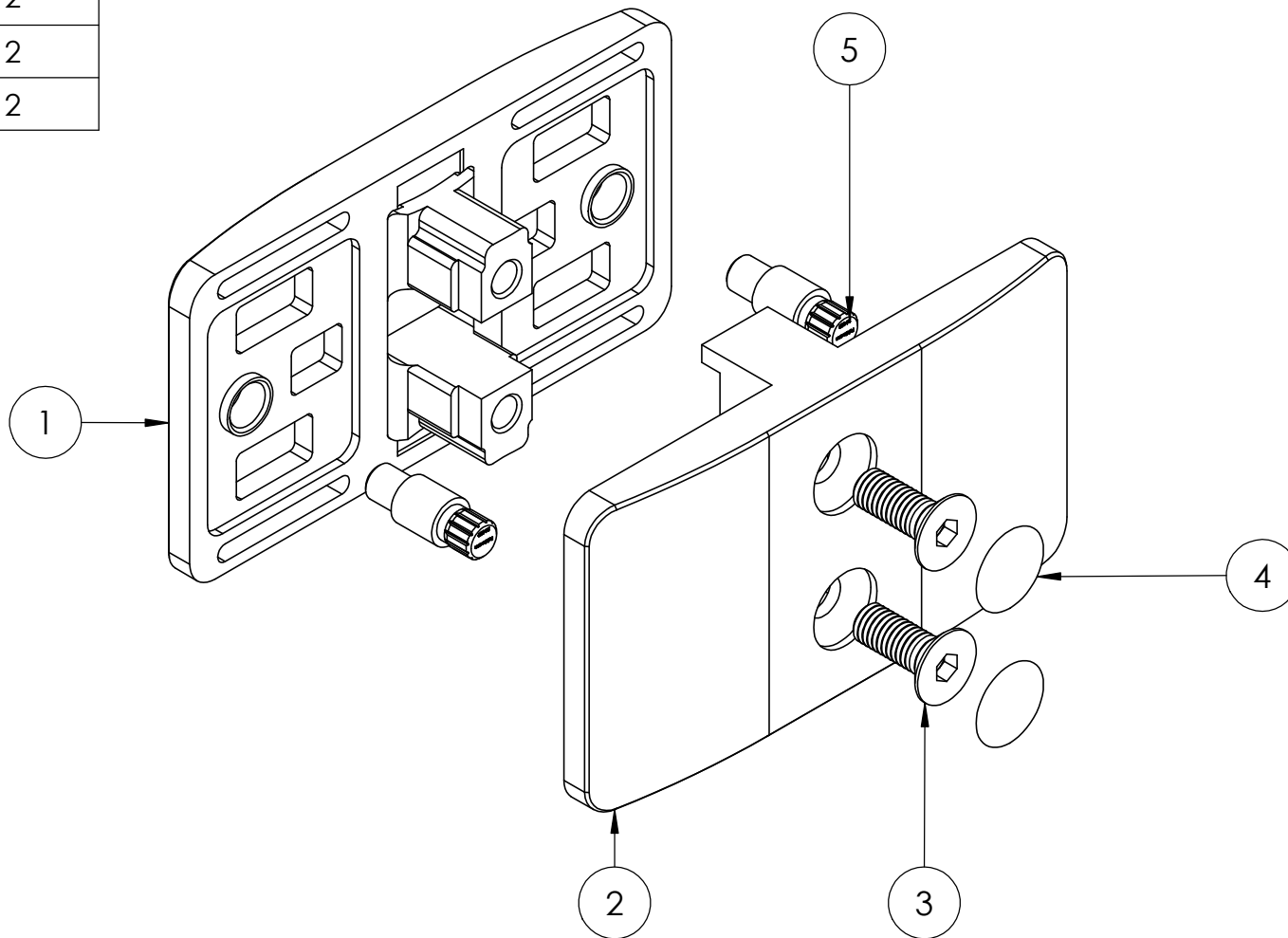

Name	Signatur	Datum	Artikelnummer	Oberfläche: Roh
Ch. Höfig	CH	31.03.2020	24-Stift	
Werkstoff: EPDM			Hersteller	Blattformat
				A4
Gewicht 0,000 kg		Massstab: 1:2	Version: 1	Blatt 1 von 6

POS-NR.	BENENNUNG	MENGE
1	24-V4A-180	1
2	24-V4A-180	1
3	DIN 7991 - M6 x 16 --- 16S	2
4	24-Kappe	2
5	24-Stift	2
6	24-Stift	2



Name	Signatur	Datum	Artikelnummer	Oberfläche: Geschliffen Korn 240
Ch. Höfig	CH	31.03.2020	24-V4A-180	
Werkstoff: 1.4401/04 (X5CrNiMo17-12-2)			Hersteller	Blattformat
			 Feldmann EDELSTAHL-ALUMINIUM-SCHMIEDEISEN	A4
Gewicht 0,484 kg		Massstab: 1:2	Version: 1	Blatt 1 von 6